

Bild / Picture

Anwendung / Application

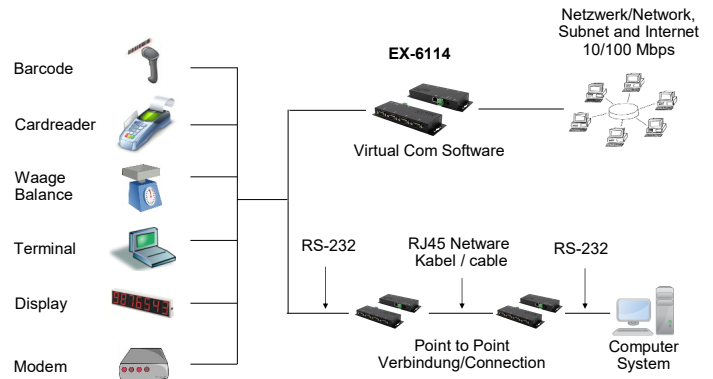

4 x Seriell RS-232 zu Ethernet Metallgehäuse



4 x Serial RS-232 to Ethernet, Metal housing

Beschreibung

Description

Die EX-6114 ist ein Serieller Multiprotokoll RS-232 Geräteserver, der für den Anschluss von seriellen RS-232 Geräten, einschließlich POS, Barcode-Lesegeräten, Sensoren, Messgeräten, Wäge Systemen, CNC-Steuerungen und SPS, an ein IP-basiertes Ethernet-Netzwerk ausgelegt ist. Die seriellen Geräte sind an Ethernet angeschlossen und im Sub-Netz und Internet zur gemeinsamen Nutzung verfügbar, wobei die Fernkonfiguration über die umfangreichen Netzwerkprotokolle wie TCP-Server, TCP-Client, UDP, VCOM, serielles Telnet, RFC2217, Remote-Pair-Master-Slave, Modbus RTU erfolgt. Um abwärtskompatibel mit dem seriellen Legacy-Gerät zu sein, auf dem die vorhandene COM-Port-Anwendungssoftware läuft, bietet die EX-6114 einen virtuellen COM-Port (VCOM), der Ihre serielle Anwendung perfekt migriert, ohne die Software zu modifizieren. Darüber hinaus können serielle Geräte mit dem Remote-Pair-Master-Slave-Modus über den Peer-to-Peer-Modus miteinander kommunizieren, ohne dass ein zwischengeschalteter PC oder Konvertierungssoftware erforderlich ist.

The EX-6114 is a multi-protocol RS-232 serial device server designed to connect RS-232 serial devices, including POS, barcode readers, sensors, meters, weighing systems, CNC controllers and PLCs, to an IP-based Ethernet network. The serial devices are connected to Ethernet and available for sharing on the sub-network and Internet, with remote configuration via the extensive network protocols such as TCP server, TCP client, UDP, VCOM, serial Telnet, RFC2217, remote pair master slave, Modbus RTU. To be backward compatible with the legacy serial device running the existing COM port application software, the EX-6114 provides a virtual COM port (VCOM) that perfectly migrates your serial application without modifying the software. In addition, serial devices with remote pair master-slave mode can communicate with each other via peer-to-peer mode without the need for an intermediary PC or conversion software.

Merkmale

Features

• Schnittstelle RS-232 V.24	• Interface: RS-232 V.24
• 15 KV ESD Überspannungs-Schutz für alle Seriellen Signale	• 15KV ESD Surge Protection for all serial signal
• Daten Bits: 5, 6, 7, 8 / Parity: None, Even, Odd, Mark, Space	• Data Bits: 5, 6, 7, 8 / Parity: None, Even, Odd, Mark, Space
• RS-232 Signale: TXD, RXD, RTS, CTS, DTR, DSR, DCD und GND	• RS-232 Signal: TXD, RXD, RTS, CTS, DTR, DSR, DCD und GND
• Ethernet Protokoll: TCP Server, TCP Client, UPD, VCOM, Serial Telnet RFC2217, Remote-Pair-Master-Slave, Modbus Server Modbus Client	• Ethernet Protocol: TCP Server, TCP Client, UPD, VCOM, Serial Telnet RFC2217, Remote-Pair-Master-Slave, Modbus Server Modbus Client
• Direktzugriff über Socket Port	• Direct connection with Socket Port
• Punkt zu Punkt Verbindung, benötige keine Software	• Point to point connection, don't need any software
• Inklusive Virtuelle COM Software	• Included Virtual COM Software
• Robustes Metallgehäuse Wandmontage und DIN-Rail Kit	• Rugged Metal Case with Wall-Mount and Din-Rail Kit

System / OS

Geprüft / Approved

Verpackung / Packaging



Spezifikation

Specification

Datentransfer-Rate:	Seriell RS-232: bis 921.6KBAud Ethernet: 10/100Mbps	Data transfer rate:	Serial RS-232: up to 921.6KBAud Ethernet: 10/100Mbps
Anschlüsse:	4x RS-232 9 Pin Stecker 1x RJ45 Ethernet 1x +12V DC-Jack (5.5 x 2.1mm)	Connectors:	4x RS-232 9 pin male 1x RJ45 Ethernet 1x +12V DC-Jack (5.5 x 2.1mm)
Hardwaresysteme:	Ethernet 10/100/1000Mbps	Hardware system:	Ethernet 10/100/1000Mbps
VCOM unterstützt Betriebssysteme:	Windows XP/ Vista/ 7/ 8.x/ 10 (32/64Bit)	VCOM support the Operating System:	Windows XP/ Vista/ 7/ 8.x/ 10 (32/64bit)
Betriebssysteme:	Alle über IP und Port Nummer (Direktzugriff über Socket Port)	Operating systems:	All via IP and port number (direct access via socket port)
Betriebstemperatur :	0°C bis +60°C	Operating temperature :	32°F up to 131°F
Lagertemperatur:	-20°C bis +75°C	Storage temperature:	-40°F up to 167°F
Rel. Luftfeuchtigkeit:	5% bis 95%	Rel. Humidity:	5% to 95%
Schutzklasse:	IP 30	Protection class:	IP 30
Stromversorgung:	+12V / 3A	Current Supply:	+12V / 3A
Stromverbrauch:	170mA@12V	Power consumption:	170mA@12V
Abmessung:	179.00 x 59.50 x 23.00 mm	Size:	179.00 x 59.50 x 23.00 mm
Gewicht:	691 g	Weight:	691 g
EAN:	4718359061141	EAN:	4718359061141
Ursprungsland:	Taiwan	Country of origin:	Taiwan
Lieferumfang:	EX-6114, Netzteil 12V/3A, Treiber CD, Handbuch	Packaging contents:	EX-6114, Power Supply 12V/3A, Driver CD, Manual

Maße / Dimension

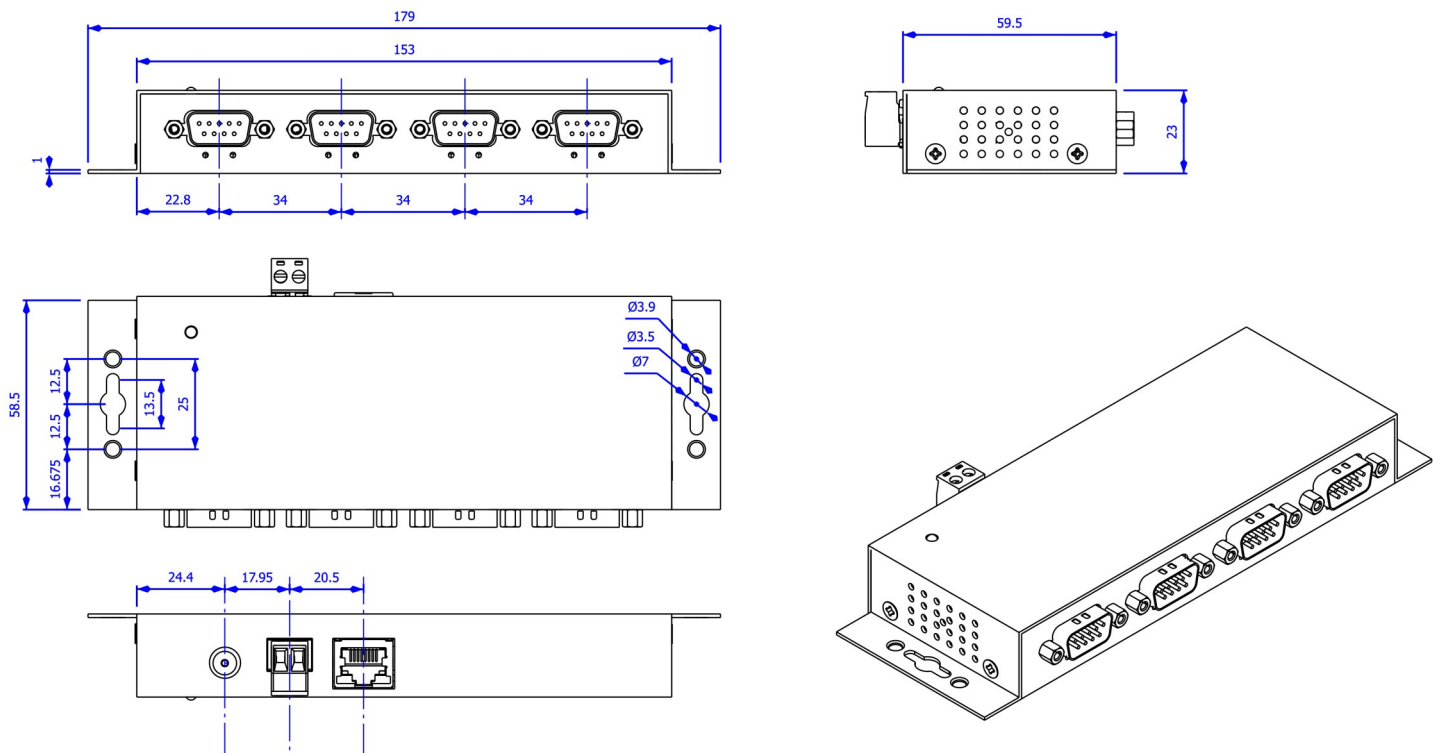

Bilder / Picture



Vergleichs Tabelle / Comparison Chart

Model No.	Serielle Schnittstelle/ Serial Interface	Anschlüsse/ Ports	Optical Isolation	Powered by PoE (PD)	Anschlussart/ Connector(s)	Input Power (DC)	Netzteil / Power Supply	Wall and DIN Rail Mounting Options
EX-6111	RS232	1	-	-	Male DB9	5V	5V / 4A	✓
EX-6111PoE	RS232	1	-	✓	Male DB9	5V	5V / 4A	✓
EX-6121	RS232/RS422/485	1	-	-	Male DB9	5V	5V / 4A	✓
EX-6121PoE	RS232/RS422/485	1	-	✓	Male DB9	5V	5V / 4A	✓
EX-6112	RS232	2	-	-	Male DB9	5~24V	12V / 3A	✓
EX-6112PoE	RS232	2	-	✓	Male DB9	5~24V	12V / 3A	✓
EX-6122	RS232/RS422/485	2	-	-	Male DB9	5~24V	12V / 3A	✓
EX-6122PoE	RS232/RS422/485	2	-	✓	Male DB9	5~24V	12V / 3A	✓
EX-6114	RS232	4	-	-	Male DB9	5~24V	12V / 3A	✓
EX-6114PoE	RS232	4	-	✓	Male DB9	5~24V	12V / 3A	✓
EX-6124	RS232/RS422/485	4	-	-	Male DB9	5~24V	12V / 3A	✓
EX-6124PoE	RS232/RS422/485	4	-	✓	Male DB9	5~24V	12V / 3A	✓